



# Design Details

Explore everything you receive from  
Direct Supply's professional design service

# Looking to Renovate or Reposition Your Community?

From concept to completion, count on one convenient point of contact to deliver high-impact aesthetics backed by outrageous service at every step of the design process – including logistics, delivery and installation.





# How it works

- Step 1** Kickoff
- Step 2** Understanding Your Vision
- Step 3** Design Concept, Space Plan & Budget
- Step 4** Design Presentation
- Step 5** Design Documentation
- Step 6** See the Transformation



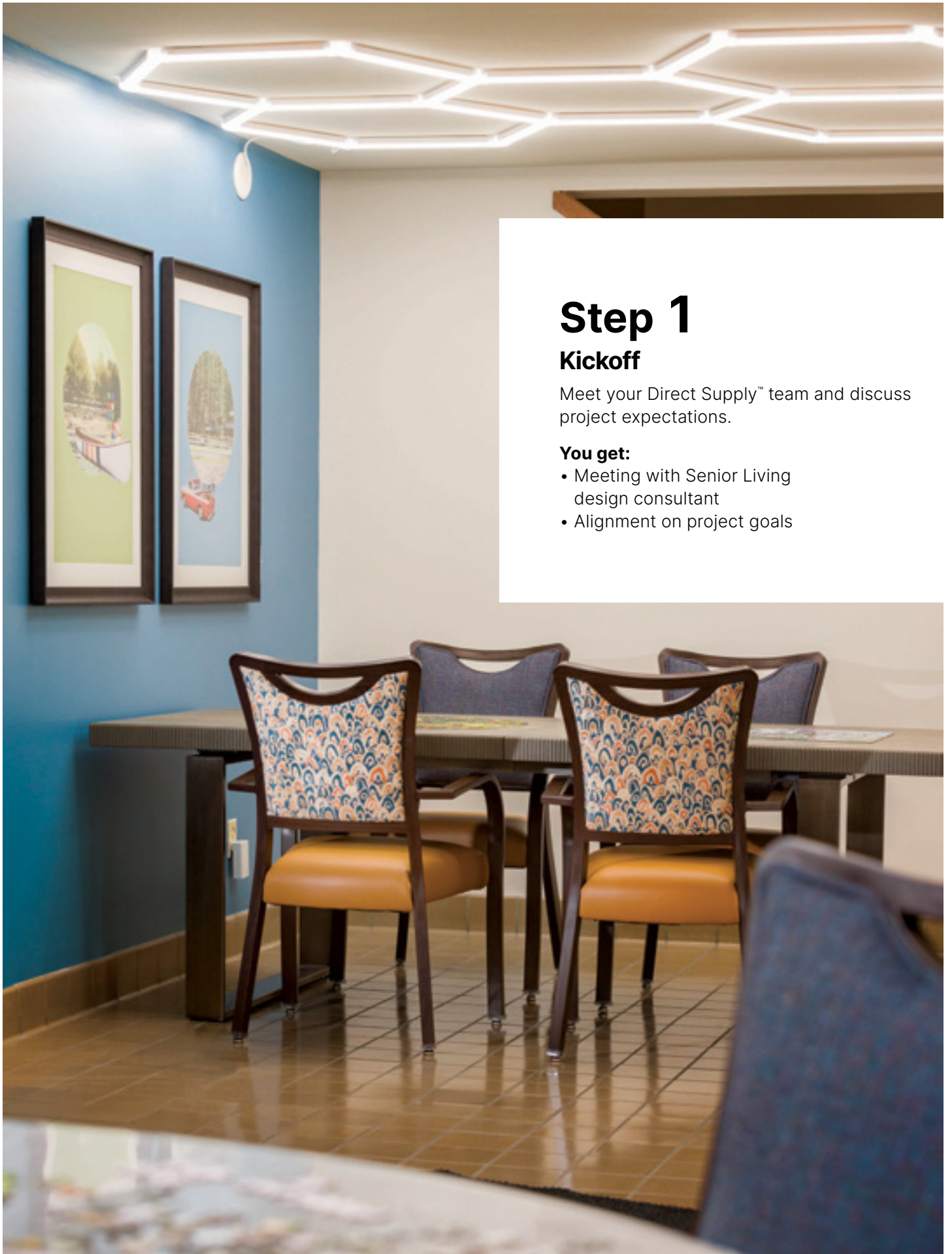

# Step 1

## Kickoff

Meet your Direct Supply™ team and discuss project expectations.

### You get:

- Meeting with Senior Living design consultant
- Alignment on project goals



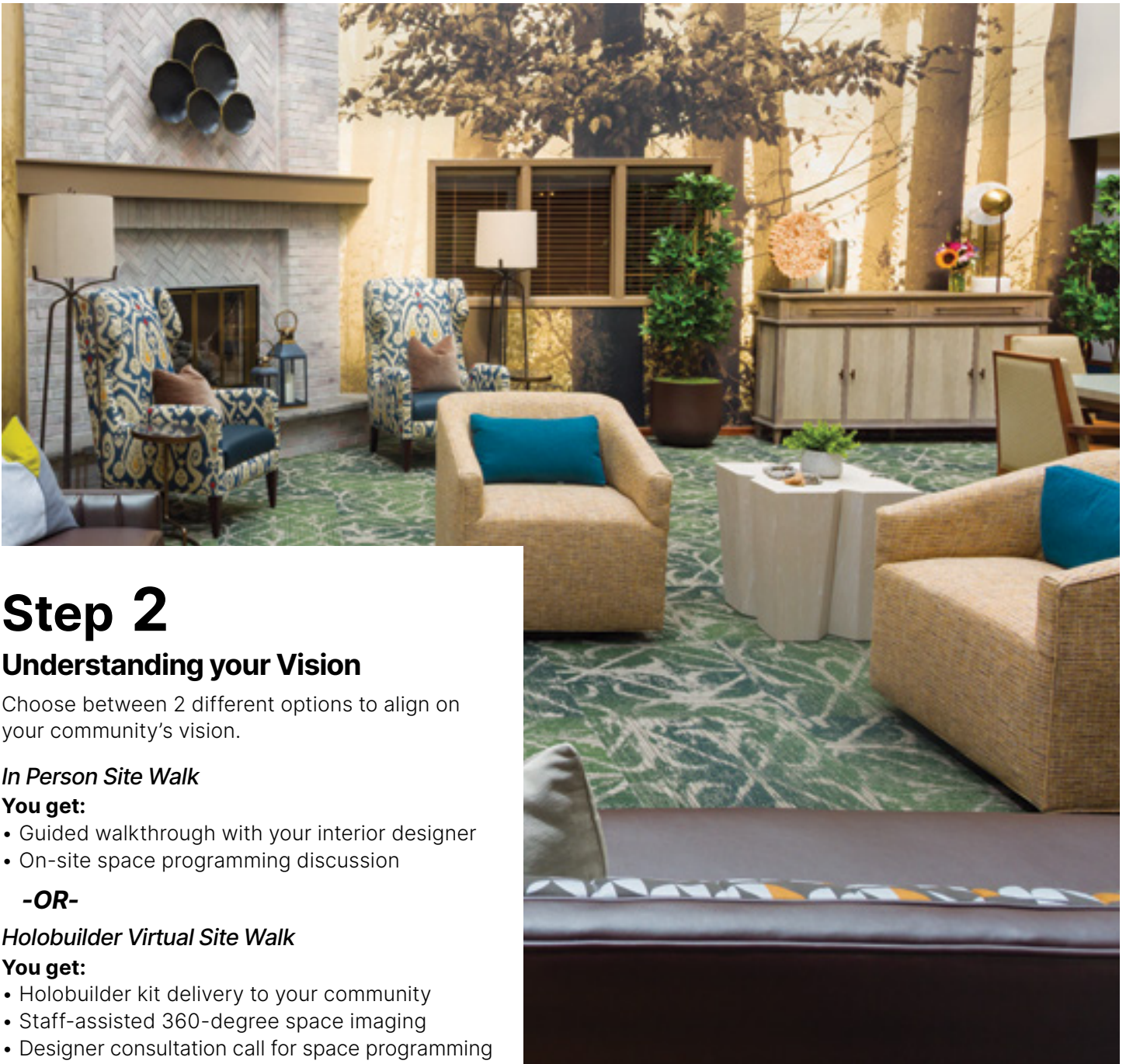

# Step 2

## Understanding your Vision

Choose between 2 different options to align on your community's vision.

### *In Person Site Walk*

**You get:**

- Guided walkthrough with your interior designer
- On-site space programming discussion

**-OR-**

### *Holobuilder Virtual Site Walk*

**You get:**

- Holobuilder kit delivery to your community
- Staff-assisted 360-degree space imaging
- Designer consultation call for space programming



# Step 3

## Design Concept, Space Plan & Budget

Developed by your design consultant to outline furnishings placement and costs so there are no surprises.

**You get:**

- Design concept statement
- Access to 200+ Senior Living brands, including Maxwell Thomas® furnishings
- Budget outline by area
- Space plans created in AutoCAD
- Estimated delivery and installation costs

# Step 3

## Concept Narrative

Align on programming needs, project goals and design direction

---

### CONCEPT STATEMENT

ABC Senior Living, located in Southlake, Texas, is renovating their Assisted Living third floor. The design will transform the outdated spaces with a balance of light neutrals, warm grays and clean, crisp white trim to produce a bright, revitalized space. Rich navy hues, lively oranges and ruby red tones will pop against the neutral backdrop, giving the community a timeless and classic elegance. By blending modern organic and geometric patterns with a historic furniture piece like a classic wingback chair, the design will create a lively yet comfortable environment with a hill-country feel for all residents and family to enjoy.



### DESIGN CONCEPT



## Furniture Space Plans

Create room-by-room furniture layouts

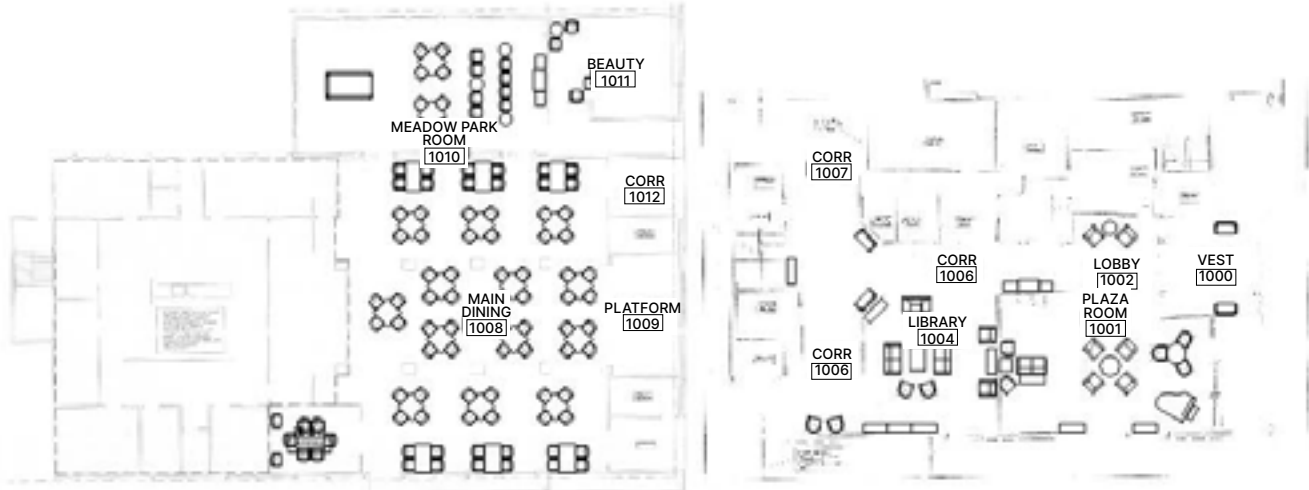

## Budget Estimate

Provide budgetary estimate for furniture, artwork, window treatments, accessories, interior signage, delivery and installation

Project:	
Project #:	
Date:	
Revised:	

**DIRECT SUPPLY**

**FF&E Budget Estimate Summary**

ROOM NAME	BUDGET TOTAL
100C CORRIDOR	\$1,170.00
100L LOBBY	\$4,480.00
100S CORRIDOR	\$4,100.00
102 PRIVATE DINING	\$7,010.00
103 DINING	\$22,960.00
104 WAITING/DINING	\$12,220.00
106 GREAT HALL	\$15,840.00
109 SALON	\$3,230.00
115 RECEPTION	\$430.00
136 OFFICE A	\$2,230.00
137 OFFICE B	\$2,230.00
138 NURSE	\$210.00
140 STAFF	\$1,340.00
141 MAINTENANCE	\$1,220.00
142B BENTLEY	\$210.00
150 TOILET	\$200.00
154 STAFF STG	\$730.00
2 STAIR	\$1,590.00
200 LANDING	\$5,570.00
200 SPA	\$460.00
200S CORRIDOR	\$1,160.00
202 ACCESSORY STORAGE	\$17,620.00
203 ACTIVITY	\$11,980.00
DINING PATIO	\$7,910.00
GREAT HALL PATIO	\$5,180.00
LOBBY PATIO	\$4,350.00
MODEL ROOM	\$0,490.00
WAITING/DINING PATIO	\$5,110.00
ARTWORK PACKAGE PLACEHOLDER	\$13,180.00
SOFT GOODS- PACKAGE PLACEHOLDER	\$17,860.00

Sub-Total:	\$177,140.00
Delivery:	\$15,950.00
Installation:	\$31,880.00
Approx Tax:	\$14,390.00
<b>TOTAL*:</b>	<b>\$239,360.00</b>

\* The budget estimate includes pricing for the purchase and procurement of all items outlined in the approved Scope of Work. Freight and logistics are included. This budget estimate is valid for the 2019 calendar year.

All rights reserved. This document may not be reproduced without express written consent from Aptura.

Sub-Total: \$177,140.00  
 Delivery: \$15,950.00  
 Installation: \$31,880.00  
 Approx Tax: \$14,390.00  
**TOTAL\*:** **\$239,360.00**



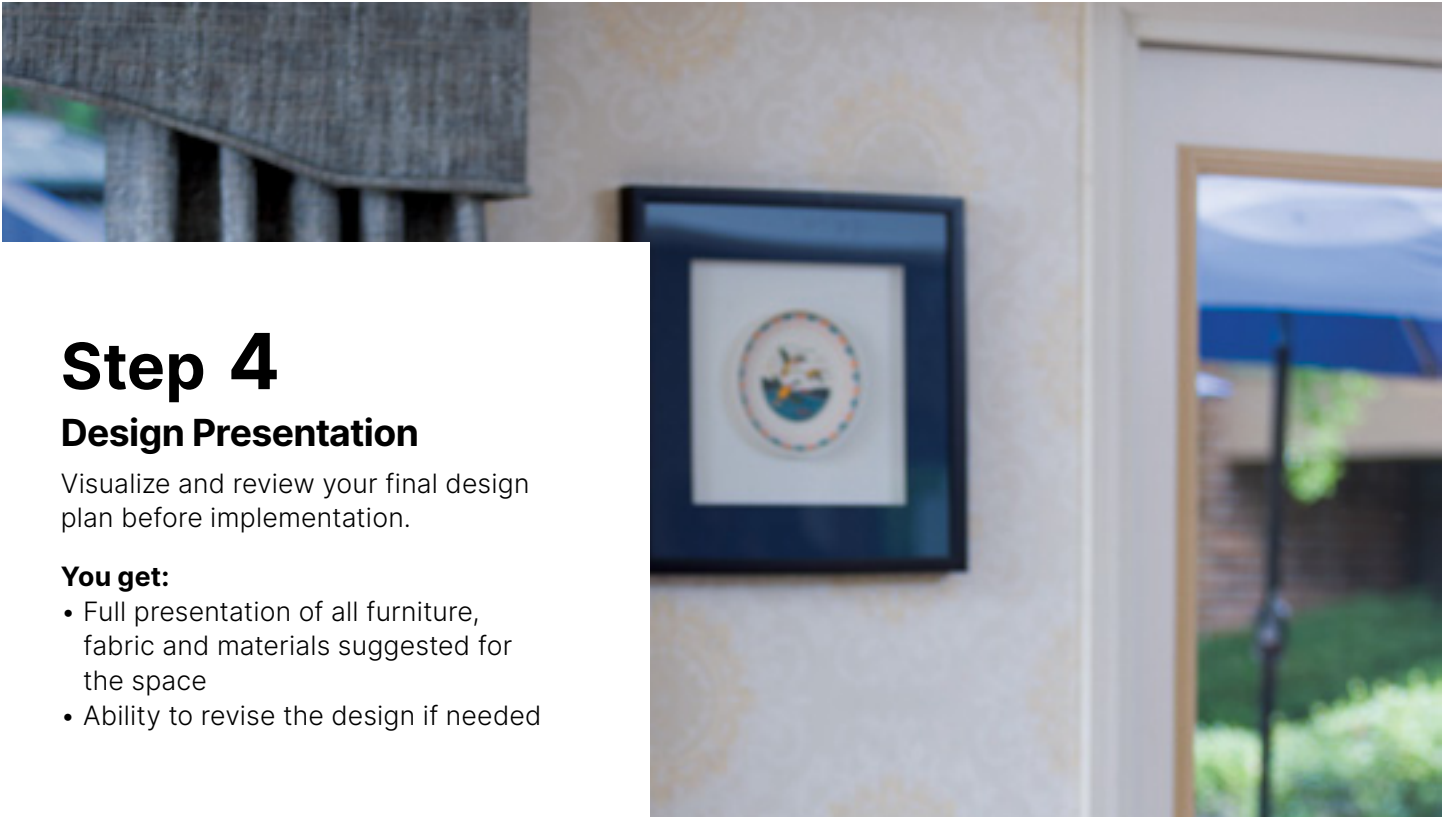

# Step 4

## Design Presentation

Visualize and review your final design plan before implementation.

**You get:**

- Full presentation of all furniture, fabric and materials suggested for the space
- Ability to revise the design if needed





## Design Presentation

Present design at Direct Supply campus or over video conference

---

### ELEVATOR LOBBY



### DINING/ACTIVITIES



# Step 4

## Design Presentation

Present design at Direct Supply campus or over video conference

---

### STAFF OFFICES



### COVERED TERRACE





# Step 4

Present design at Direct Supply campus or over video conference

**SALON**



**ARTWORK**



# Step 4

## Design Presentation

Present design at Direct Supply campus or over video conference

### SIGNAGE OPTIONS

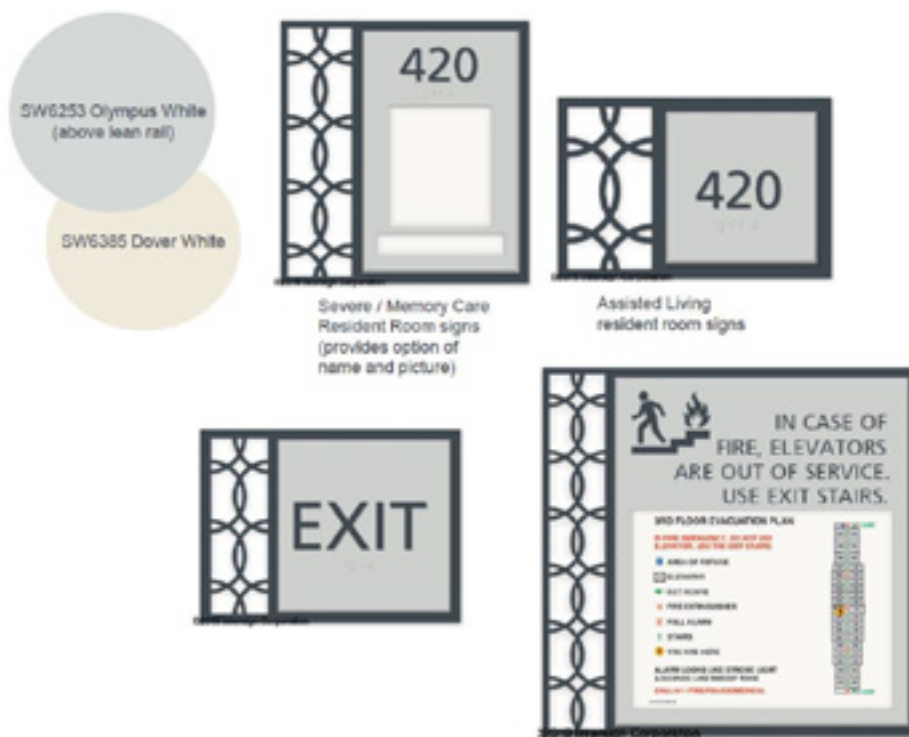

### WINDOW TREATMENTS





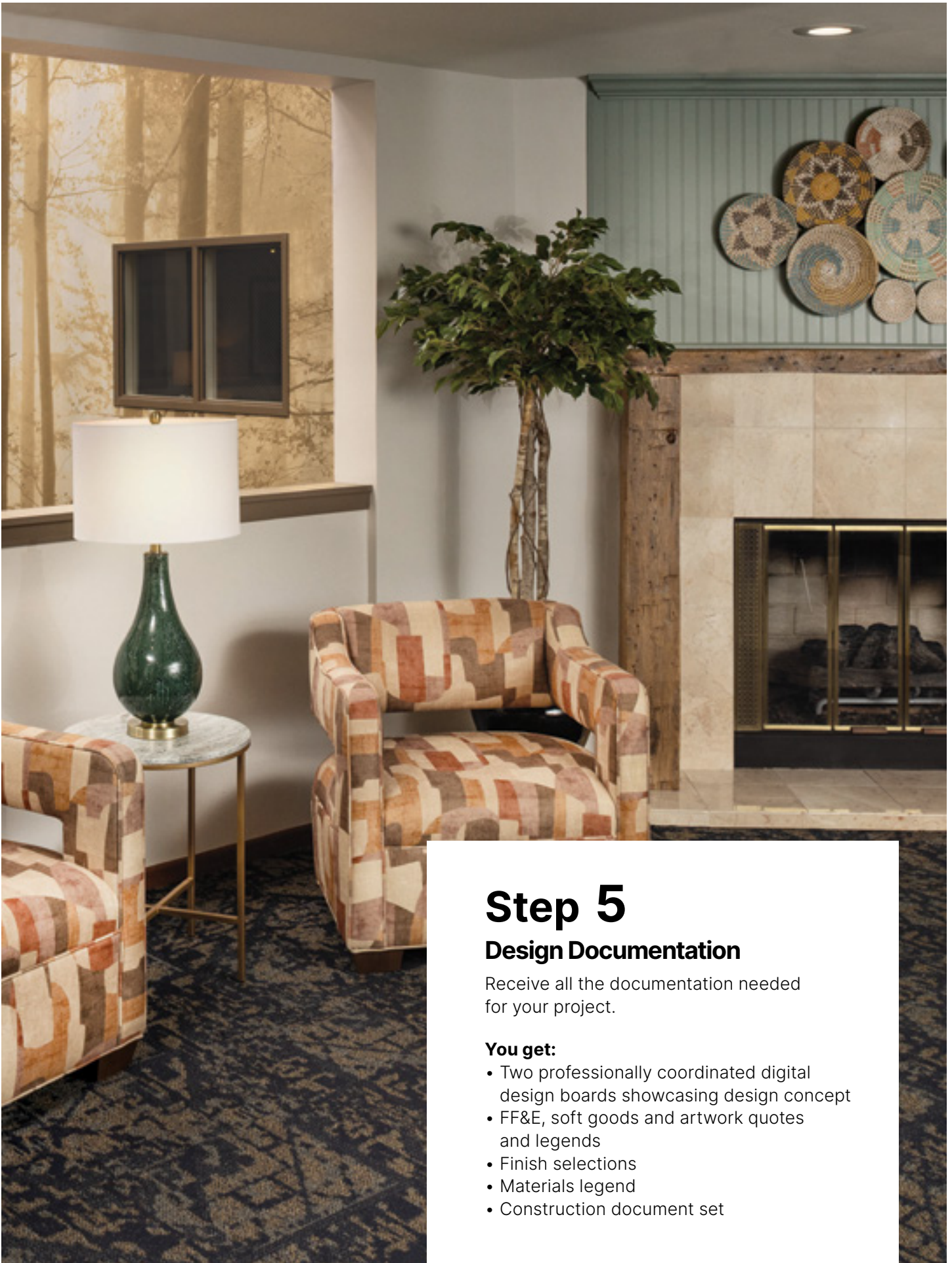

## Step 5

### Design Documentation

Receive all the documentation needed for your project.

**You get:**

- Two professionally coordinated digital design boards showcasing design concept
- FF&E, soft goods and artwork quotes and legends
- Finish selections
- Materials legend
- Construction document set

# Step 5

## Digital Design Boards

Two 12" x 18" design boards

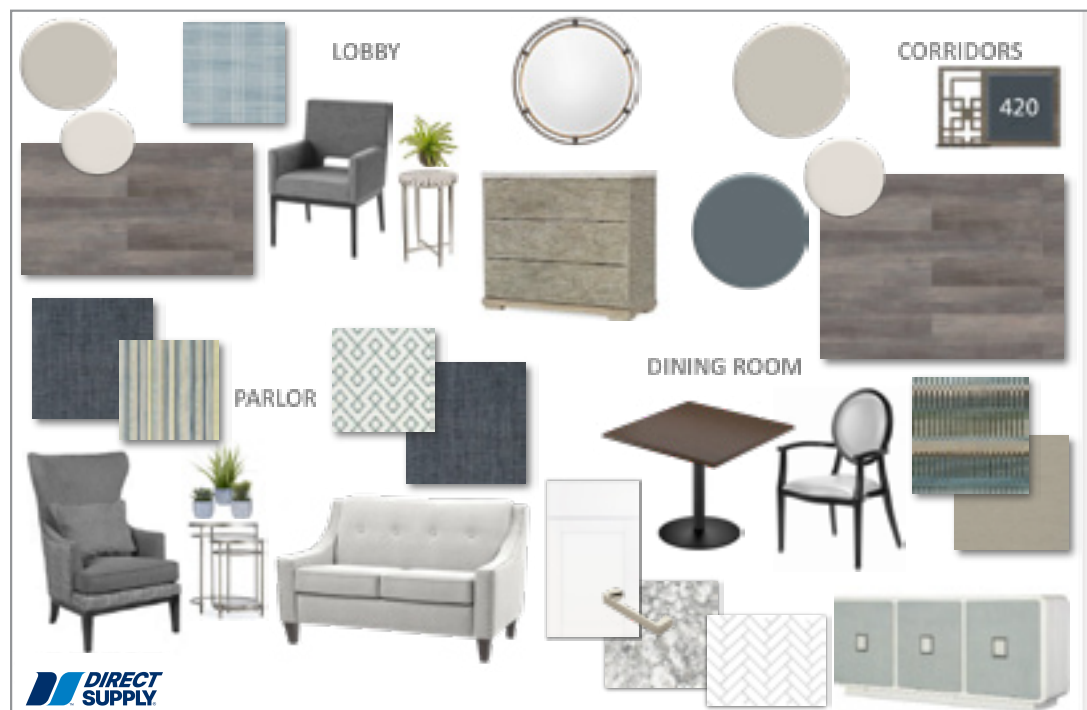



















## Legends

Provide legend documentation for furniture, window treatments, artwork, signage and accessories

**Project Name: Sample at Senior Living**  
**Project #: 10136390**















LOCATION	CODE	QTY.	UNIT MEASURE	MANUF.	MANUF. MODEL #	ITEM DESCRIPTION	DIMENSIONS	FINISH	FABRIC MFG. PATTERN COLOR	PATTERN REPEAT	PRODUCT IMAGE	FABRIC IMAGE	FINISH IMAGE	PRICE	EXT. PRICE
<b>100 IL LOUNGE</b>															
100 IL LOUNGE	CA-1	1	EACH	Universal Furniture	751964	Curated Meritt Entertainment Console	37H x 85W x 21D	As Shown	-	-		-	-	\$1,024.00	\$1,024.00
100 IL LOUNGE	CH-1	12	EACH	Direct Supply Manufacturing	CS-630-COM	Maxwell Thomas, Gainesville Counter Stool w/ Arms	43-3/4H x 23-3/4W x 23-1/2D	Metal Finish: Kicksplate: Silver	Back: Maharam-Kindred Chestnut-Rainforest; Seat: Burch-Cansel Black	Back: SFW Repeat: 0'Y, 18.75"; Seat: SF4W Repeat: NA				\$335.00	\$4,020.00
100 IL LOUNGE	TA-1A	3	EACH	Direct Supply Manufacturing	Thermo5FRD-XXS	Maxwell Thomas Thermolaminate Tabletop, Bullnose Edge, 36 Round - CUSTOM	36" W x 36" D	Ivory Biscayna	-	-		-		\$187.00	\$561.00
100 IL LOUNGE	TA-1B	3	EACH	Direct Supply Manufacturing	9004-3030	Moswell Thomas Nexus Metal Table Base for 36" Round Table Tops - CUSTOM	36" W x 36" D	Black	-	-		-		\$65.00	\$195.00
<b>1000 NURSE STATION</b>															
1000 NURSE STATION	AC-1	1	EACH	Surya	ORB-002	Ob	10.5" W x 7" W x 7" D	As Shown	-	-		-	-	\$44.00	\$44.00
1000 NURSE STATION	AC-2	1	EACH	Surya	ORB-001	Ob	8" H x 9" W x 9" D	As Shown	-	-		-	-	\$35.00	\$35.00
1000 NURSE STATION	AC-3	1	EACH	Surya	CM4001-S	Carissima Metal Vase	13" H x 16" W x 6" D	As Shown	-	-		-	-	\$84.00	\$84.00
												-	-	\$136.00	\$136.00
														\$1,039.00	\$2,078.00
												-	-	\$1,749.00	\$1,749.00

**Project Name: Sample at Senior Living**  
**Project #: 10136390**



### Artwork Legend













LOCATION	CODE	QTY.	UNIT MEASURE	MANUF.	MANUF. MODEL #	ITEM DESCRIPTION	DIMENSIONS	FINISH	PRODUCT IMAGE	FINISH IMAGE
<b>FITNESS 129</b>										
Fitness 129	A-001	1	EACH	Wendover Art Group	WAG29100C	Moroccan Spice, M1111, Canvas, Security Mount.	58"W x 18"H	M1111, No Mat		
Fitness 129	A-002	1	EACH	Wendover Art Group	29141590485A	CASCADE METAL WALL CLOCK WITH ROPE, None, Outside Print, Glass, Security Mount.	0"W x 0"H			
Fitness 129	A-003	1	EACH	Wendover Art Group	A0087NS	River Rocks, MC0779, Matte Paper, Glass, Security Mount.	20"W x 38"H	MC0779, Deckle & Floated		
Fitness 129	A-004	1	EACH	Wendover Art Group	WAG16149M	Barnscape 2, MC0658, Watercolor Paper, Glass, Security Mount.	30"W x 30"H	MC0658, 3" Double White		
Fitness 129	A-005	1	EACH	Wendover Art Group	A0015SR	Barn on Lakeville Hwy, M1111, Canvas, Security Mount.	35"W x 39"H			
<b>CORRIDOR 25</b>										
Corridor 25	A-006	1	EACH	Wendover Art Group	44491285520A	CLASSIC MEDALLION, None, Outside Print, Glass, Security Mount.	0"W x 0"H			

All rights reserved. This document may not be reproduced without express written consent from Direct Supply Inc.

**Project Name: Sample at Senior Living**  
**Project #: 10136390**



### Soft Goods Legend

LOCATION	CODE	QTY.	UNIT MEASURE	MANUF.	MANUF. MODEL #	ITEM DESCRIPTION	DIMENSIONS	FINISH	FABRIC MFG. PATTERN COLOR	PATTERN REPEAT	PRODUCT IMAGE	FABRIC IMAGE	FINISH IMAGE
<b>114 LIVING</b>													
114 LIVING	WT-1	4	EACH	HCI	CUSTOM	Fair Stationary Rod Pocket Panels - Open Lines Pinch Pleat Operable floor length panels on existing rod. 110% Fullness	20 X 95.5	-	Robert Allen: Open Lines Storm - (Rainforest)	118"; Repeat: 0'Y, 2.5"			
<b>112 DINING</b>													
112 DINING	WT-2	1	EACH	HCI	CUSTOM	Fair Stationary Rod Pocket Panels - Valance Pinch Pleat Operable floor length panels on existing rod. 110% Fullness	20 X 101.2	-	Fabricout: Valence Storm	SFW; Repeat: NA			
112 DINING	WT-2	1	EACH	HCI	CUSTOM	Fair Stationary Rod Pocket Panels - Valance Pinch Pleat Operable floor length panels on existing rod. 110% Fullness	20 X 97.5	-	Fabricout: Valence Storm	SFW; Repeat: NA			
112 DINING	WT-2	1	EACH	HCI	CUSTOM	Fair Stationary Rod Pocket Panels - Valance Pinch Pleat Operable floor length panels on existing rod. 110% Fullness	20 X 97.75	-	Fabricout: Valence Storm	SFW; Repeat: NA			

# Step 5

# Procurement Documentation

Produce finalized service agreement and documentation to execute design



## Product & Services Agreement

**Project Name:** Sample Senior Living  
**Project #:** 10000234

Direct Supply Aptura™, a division of Direct Supply, Inc. is pleased to provide Sample Senior Living with the following Products and Services Agreement which outlines services, deliverables, and fees for your project referenced above.

The following documents provide detail on the products and services being procured by Aptura, and which form part of our Product & Services Agreement and will apply throughout the relationship between you and us until the SOW is otherwise changed or terminated:

- Delivery and Installation ("D&I") Services
- Standard Terms and Conditions
- Attached References listed below

Document Title
Artwork Legend
Furniture Legend
Soft Goods Legend

By signing below, you acknowledge and agree that:

- You have reviewed and understand this Agreement and understand that this Agreement is subject to the attached References.
- A 25% down payment is required to execute this Agreement.
- We will invoice you in accordance to the Standard Terms and Conditions.
- The base fee for products and procurement services is: **\$255,289.10**

Each person signing below represents that they have the authority to bind the entity named below.  
**CLIENT: Sample Senior Living**      **DIRECT SUPPLY, INC.**

By: \_\_\_\_\_      By: **<<Signature>>**  
 Name: \_\_\_\_\_      Name: **<<Partner Name>>**  
 Title: \_\_\_\_\_      Title: **<<Partner Title>>**  
 Date: \_\_\_\_\_      Date: **MM/DD/YYYY**

Address for Notices:  
 Direct Supply, Inc. – Legal Affairs  
 6767 North Industrial Road  
 Milwaukee, WI 53223



**Materials Legend**

Contractor may purchase materials from Aptura by calling 888-634-7330, faxing 888-609-8643, or emailing ApturaContractorSales@directcs.com. Contractor responsible for all take-off quantities.

CODE	MATERIAL	MANUFACTURER	ITEM #	DESCRIPTION	COLOR	NOTES
<b>FINISHES ARCHITECTURAL WOODWORK (Division 05 00 00)</b>						
RR-1	Chair Rail	Fence or Equal	FR10	Paint Grade Chair Rail, 2x4	PA-1, GL	
RR-1	Wood Handrail	CS/Acrylic, or equal	HRW-35	Solid Stain-Grade Maple Handrail, 3-1/2"H	Control Color-match to Walnut Heights, Satin Finish	Include manufacturer's mounting hardware.
PLAM-1	Plastic Laminate	Wilsonart	7960K-12	Standard Laminate	Walnut Heights	Reface Existing Apron and Cabinetry
WDB-1	Wood Base	TBD by Contractor	TBD by Contractor		STN-1, SA	
<b>TILE - Division 9 (09 00 00)</b>						
PT-1	Porcelain Tile	Grato	GR33	Espresso, 2" x 2" Tile Mosaic, 1/2" x 20" Mesh	Marone Chiaro	Floor Tile
PT-2	Porcelain Tile	Grato	GR33 1212192	Espresso, 12" x 12"	Marone Chiaro	Wall Tile
PT-AG-1	Porcelain Tile Accessory	P.A.C.O.		Espresso, 1/2" x 12" Bullnose	Marone Chiaro	Handmade
PTB-1	Porcelain Tile Base	Grato	GR36C219	Espresso, 6" x 12" Cove Base	Marone Chiaro	Base
DIR-1	Grout	Mapel	-	Unadhered grout BioBlock Kerapoxy w/ Antimicrobial Protection	44 Pale Umber	Use on Floors
DIR-2	Grout	Mapel	-	Unadhered grout BioBlock Kerapoxy w/ Antimicrobial Protection		Use on Walls
<b>RESILIENT FLOORING - Division 9 (09 05 00)</b>						
RIR-1	Resilient Base	Johnsonite	4" Cove Base	4" Cove Base	001 Snow White	Include all applicable accessories
RTR-1	Transition Strip-Resilient	Johnsonite or equal		ADA Compliant Transition Strip	001 Snowwhite	Include all applicable accessories
TRM-1	Transition Strip-Metal	Scholar or equal		ADA Compliant Transition Strip	001 Snowwhite	Include all applicable accessories
VCT-1	Vinyl Composition Tile	Mannington		Essential Standard VCT, 12" x 12"	009 Biscuit	Include all applicable accessories
VT-1	Vinyl Tile	Ametec	025W2020	Spacia Vinyl Tile, 2.5mm gauge with beveled edges, urethane coating, 4"W x 36"L	025W2019 Aged Hickory	Include all applicable accessories
VT-1	Vinyl Tile	Ametec	025W4096	Spacia Vinyl Tile, 2.5mm gauge with beveled edges, urethane coating, 12"W x 18"L	025W4095 Blue Travertine Sand	Include all applicable accessories
<b>FLOOR CARPETING - Division 9 (09 05 10)</b>						
CPT-1	Carpet	M&J Invision	7984	Danish Modern Modular, Tip Sheared Patterned Loop, Nexus Modular Backing, Solution Dyed, 23 oz., 24" x 24" Tiles	1482 Harmony	Include all applicable accessories
CPT-2	Carpet	M&J Invision	7983	Minimalist Modular, Tip Sheared Patterned Loop, Nexus Modular Backing, Solution Dyed, 23 oz., 24" x 24" Tiles	1482 Harmony	Include all applicable accessories
<b>SHEET CARPETING - Division 9 (09 05 10)</b>						
CPT-1-ALT	Carpet	M&J Invision	6553	Danish Modern 12' Broadloom, Tip Sheared Pattern Loop, PremierPlus Plus, Solution Dyed, 23 oz.	1482 Harmony	Include all applicable accessories
CPT-2-ALT	Carpet	M&J Invision	6652	Minimalist 12' Broadloom, Tip Sheared Pattern Loop, PremierPlus Plus, Solution Dyed, 23 oz.	1482 Harmony	Include all applicable accessories
CPT-3	Carpet	M&J Invision	2570	Solutions 12' Broadloom, Solution Dyed Level Loop, Premier Plus Plus, 20 oz.	1205 Bandaid	Include all applicable accessories

All rights reserved. This document may not be reproduced, copied or disseminated without the prior written consent of Aptura™, a division of Direct Supply, Inc.      Page 1 of 3

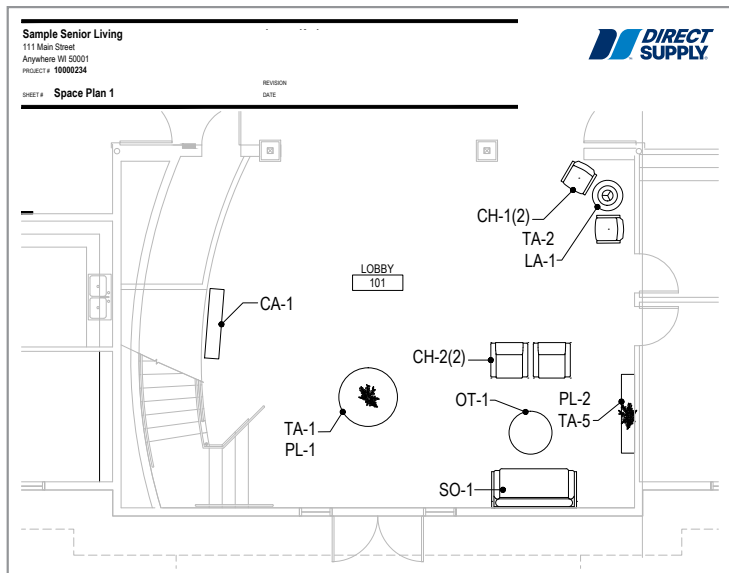





## Step 6

### See the Transformation

Orchestrated by order management and installation experts.

**You get:**

- Coordinated delivery and installation to minimize disruption to your community
- Punch list
- Compliance documentation
- Ongoing project support
- A wow-factor space that makes an amazing impression

# Step 6





## Punch List

Produce fulfillment punch list after installation

Project Name: Sample at Senior Living  
Project #: 10004679

**Furnishings Punch List**

CLIENT CONTACT: Duke Sample  
DIRECT SUPPLY CONTACT:  
ORIGINAL PUNCH LIST DATE:  
TODAY'S DATE:

ROOM NUMBER	CODE	QTY AFFECTED	ITEM DESCRIPTION	IMAGE	ISSUE	RESOLUTION / UPDATE	STATUS (OPEN/CLOSED)
Resident Room 104	TA-1	1	Geneva 3 Drawer Bedside Cabinet		Missing hardware	Replacement hardware shipped & delivered 5/6/17	Closed
Resident Room 206	CH-3	1	Willsburg Occasional Chair		Small scratch on back left leg of chair	Furniture medco scheduled for repair 5/15/17	Open
Dining 104	CH-5	1	Scottsdale Dining Chair with In-Line Wheels		Fabric rip in back of chair	Original chair left on site, sending replacement, shipping 5/26/17	Open
Dining 104	TA-4	1	Hessia Dining Cross Table Base		Drives missing to attached base to top	Replacement hardware shipped & delivered 5/4/17	Closed
hallway 206	BB-1	1	Bakersfield Bench		Scratch on leg	Furniture medco scheduled for repair 5/15/17	Open



## Fabric Compliance Documentation

Generate electronic compliance documentation of warranty information, fabric flame spreads and cleaning instructions

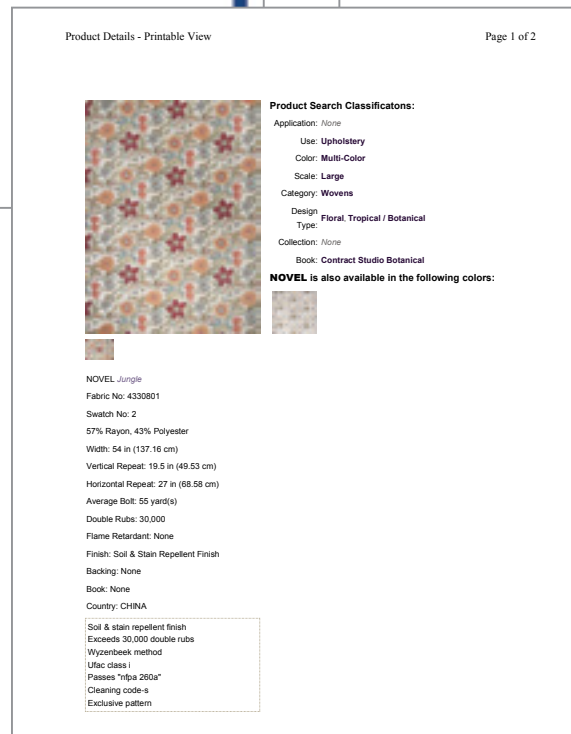
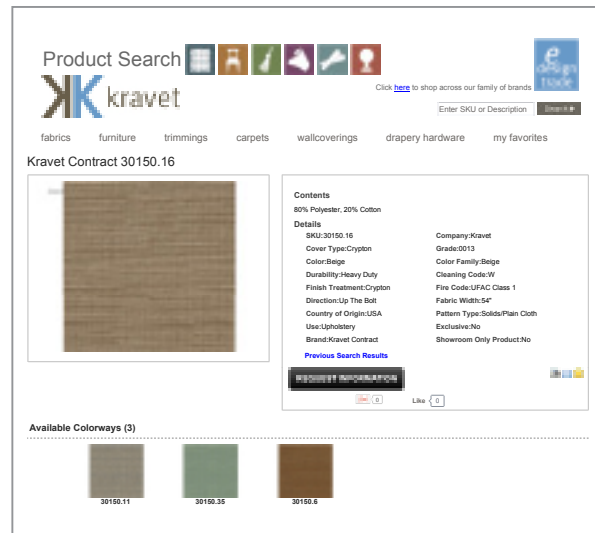

# Count on our experienced team

**35+** years of Senior Living experience

**60+** partners ready to fulfill your project





**200+** furnishings brands,  
including Maxwell Thomas®  
furnishings

**300+** design projects  
completed per year



**4,000** Senior Living  
projects per year







# Let's get started

## Project scope discussion

- Budget and timeline direction
- Materials and finish needs
- Floor plans
- Define deliverables

## Professional services contract review

- Outlines scope of services and overall relationship

## Executed contract

- All parties sign so work can begin

## Project kick-off call

- Team introductions
- Design vision alignment
- Scheduling





# Ready to start your transformation?

Visit [directsupply.com/impressions](https://directsupply.com/impressions) or call 1-800-893-7222 to learn more.

